

UPRIGHT REACH-IN REFRIGERATOR TOP MOUNT CONDENSING UNIT

Project Name: _____

Project Location: _____

Model #: _____ Quantity: _____

Available Warehouse: _____

ES Series

Model: ESR2



Refrigeration System

- Top mounted, self-contained and fully detachable Blizzard R290 condensing unit uses environmentally friendly, EPA-compliant R290 refrigerant with zero (0) Ozone Depletion Potential (ODP) and three (3) Global Warming Potential (GWP). Blizzard R290 is easily replaceable and requires no on-site brazing.
- Electronically commutated (ECM) fan motors achieve rapid cooling with less energy consumption.
- Full-length air duct system and airflow guard ensure optimal circulation of cold air.
- Time-initiated and temperature-terminated auto defrost cycle for seamless operation.
- Large capacity, corrosion-resistant condenser and evaporator coils.
- Self-maintaining, energy-efficient condensate drain pan requires no external drains or electric heaters.
- High performance, auto-reverse condenser fan motor supports compressor ventilation and condenser coil cleaning. Refer to owner's manual for full maintenance instructions.
- Pressure relief devices allow smooth access to cabinet interior when reopening doors.
- Pre-wired and ready to plug, 115V/60Hz/1Ph, NEMA 5-15P.

Cabinet Construction

- Heavy duty stainless steel interior / exterior with rounded corners for a hazard-free workspace.
- Open spaced interior with no walls between compartments.
- Galvanized steel top, bottom and rear.
- 2.5" thick high density polyurethane insulation.
- Four 5" swivel casters with locks on front set.

Lighting

- Energy efficient silicone coated and shatter-proof LED lighting provides bright, high color illumination with low heat output.

Doors

- Heavy duty stainless steel interior / exterior.
- 2.5" thick high density polyurethane insulation.
- Frame heaters prevent exterior moisture build up.
- Self-closing with adjustable torsion system for a positive seal.
- Snap-in magnetic door gasket make cleaning and replacement an easy process.
- High strength, recessed door handles.
- Pre-installed door locks keep your items safe from theft.
- Field reversible.

Shelving

- Three epoxy coated, steel wire shelves per section.
- Height adjustable stainless steel clips.

Temperature Control

- Multi-function digital controller with easy to read LED display.
- Factory preset temperature, 35°F. Temperature setting range from 33°F to 54°F.
- Audible overheat protection alarm for compressor and condenser coil.

Options

- Additional shelving.
- 3" swivel casters with locks.
- 3.5" – 6" height-adjustable and interchangeable legs.
- Left hinged door.

Operating temperature range is 33°F ~ 54°F



**5 YEAR Compressor
3 YEAR Parts & Labor**



Please visit our website for updated Energy Efficiency information

Ref/ Frz/Dual	Doors	Capacity Cu. Ft.	Shelves	Refrigerant	HP	Power V-Hz-Ph	Amps	Crated Weight	Exterior Dimensions		
									L	D	H*
REF	2	48	6	R-290	1/4+	115-60-1	4.5	401 lbs (182kg)	49.625" (1260mm)	31.625" (803mm)	74.25" (1886mm)

(†)Based on evaporating temperature of 23°F (-5°C) & condensing temperature of 131°F (55°C). (►) Product capacity is calculated based on standard industry figures. (✳) Reference plan view for clarification on caster/unit height. If dimensions and capacity are critical, please contact Everest Refrigeration. Blizzard R290 replacement is at the sole discretion of Everest Refrigeration. Specifications subject to change without notice.

UPRIGHT REACH-IN REFRIGERATOR

TOP MOUNT CONDENSING UNIT

ES Series

Model: ESR2

DIMENSIONAL DATA

External Dimensions	L	49.625" (1260mm)
	D	31.625" (803mm)
	H*	74.25" (1886mm)
Crated Weight		401 lbs. (182kg)
Doors/Drawers/Lids		2
Max Weight Support (LBS)		-

STORAGE DATA

Net Capacity Cu. Ft. ▶	48
Shelves	6
Barrels	-
20 oz. Bottles	-
12 oz. Bottles	-
12 oz. Cans	-
8" Mugs	-
# of Pans (Top)	-
# of Pans (Drawer)	-
Dividers	-
Trays	-

ELECTRICAL DATA

Voltage	115-60-1
Full Load Amperage	4.5A
Feed Wires with Ground	3
Cord Length	9ft
NEMA Plug Type	 NEMA 5-15P

REFRIGERATION DATA

Compressor Mounting	Top
Refrigerant	R-290
Compressor HP	1/4+
BTU/HR †	1926

KEY

D	Door	R	Refrigerator
L	Lid	REF	Refrigerator
H	Half Door	F	Freezer
FD	Full Door	FRZ	Freezer
SD	Solid Door	DUAL	REF/FRZ Combo
GD	Glass Door	DR	Drawer

	Elevation	Right	Plan	3D	Back

PLAN VIEW

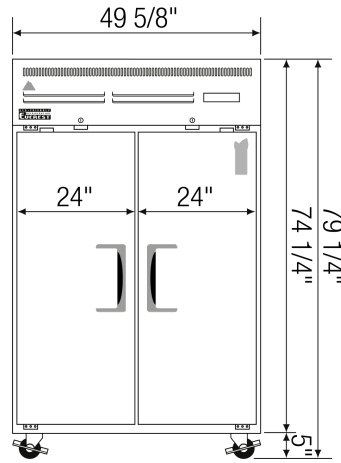

FRONT

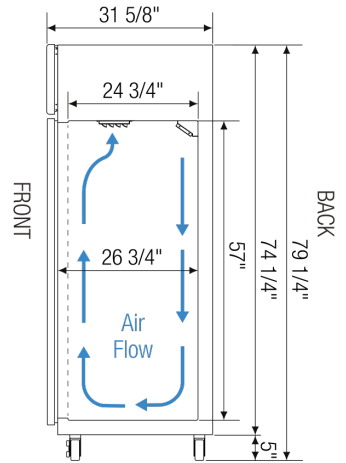

SIDE

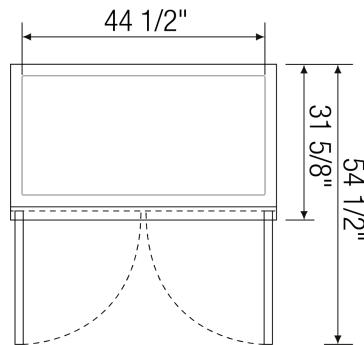

TOP

ACCESSORIES & OPTIONS

Part Number	Description
Additional Shelving	Contact Everest Refrigeration for more information.
AJL03-00	Interchangeable Leg for Caster
CASA3-01	3" Overall Height Caster Assembly - (2) Front (2) Rear
Left Hinged Door	Contact Everest Refrigeration for more information.

(†)Based on evaporating temperature of 23°F (-5°C) & condensing temperature of 131°F (55°C). (▶) Product capacity is calculated based on standard industry figures. (✖) Reference plan view for clarification on caster/unit height. If dimensions and capacity are critical, please contact Everest Refrigeration. Blizzard R290 replacement is at the sole discretion of Everest Refrigeration. Specifications subject to change without notice.