

Door & Drawer Combo Upright Reach-Ins

TOP MOUNTED CONDENSING UNIT

ES SERIES



ESR1D2

ESR2D2



ESR2D4



ESRF2D2

DUAL TEMP

ESWQ2D2

DUAL TEMP

Cabinet Construction

- Heavy duty stainless steel interior/exterior with rounded corners for a hazard-free workspace.
- Open spaced interior with no walls between compartments (Ref). Insulated interior wall between refrigerator and freezer compartments (Dual Temp).
- Galvanized steel top, bottom and rear.
- 2.5" thick high density polyurethane insulation.
- Four 5" swivel casters with locks on front set. Leg stabilizers standard for model ESR1D2.

Refrigeration System

- Top mounted, self-contained and fully detachable Blizzard R290 condensing unit uses environmentally friendly, EPA-compliant R290 refrigerant with zero (0) Ozone Depletion Potential (ODP) and three (3) Global Warming Potential (GWP). Blizzard R290 is easily replaceable and requires no on-site brazing.
- Electronically commutated (ECM) fan motors achieve rapid cooling with less energy consumption.
- Full-length air duct and airflow guard ensure optimal cold air circulation.
- Time-initiated and temperature-terminated auto defrost cycle for seamless operation.
- Large capacity, corrosion-resistant condenser and evaporator coils.
- Self-maintaining, energy-efficient condensate drain pan requires no external drains or electric heaters.
- High performance, auto-reverse condenser fan motor supports compressor ventilation and condenser coil cleaning.
- Pressure relief devices allow rapid cabinet re-entry.
- Pre-wired and ready to plug, 115V/60Hz/1Ph, NEMA 5-15P.

Lighting

- Energy efficient silicone coated and shatter-proof LED lighting provides bright, high color illumination with low heat output.

Doors & Drawers

- Heavy duty stainless steel interior/exterior.
- 2.5" thick high density polyurethane insulation.
- Frame heaters prevent exterior moisture build up.
- Self-closing with adjustable torsion system for a positive seal.
- Thick gauge, stainless steel frames with low-friction ball bearings.
- Snap-in magnetic gaskets for ease of cleaning.
- High strength, recessed handles.
- Pre-installed locks keep your items safe from theft (does not apply to drawers).

Shelving

- Epoxy coated, steel wire shelves (see table for quantity).
- Height adjustable stainless steel clips.

Temperature Control

- Multi-function digital controller with easy to read LED display.
- Factory preset temperature, 35°F for refrigerators and -4°F for freezers. Temp-set range from 33°F to 54°F for refrigerators and -10°F to 54°F for freezers.
- Audible overheat protection alarm for compressor and condenser coil.

Options

- Additional shelving.
- 3" swivel casters with locks.
- 3.5"-6" height-adjustable and interchangeable legs.

↔ = Interior Dimensions ↔ = Exterior Dimensions

ABS Legs



Two additional front adjustable stainless steel clad ABS legs for model ESR1D2 provide extra stability when opening and closing doors.



Equipped with 9 ft long NEMA 5-15P plug.

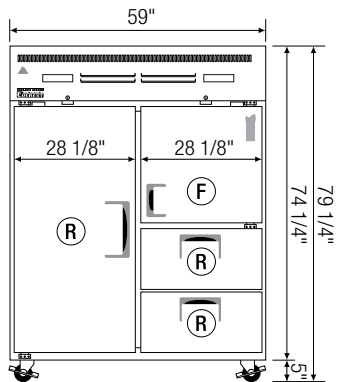
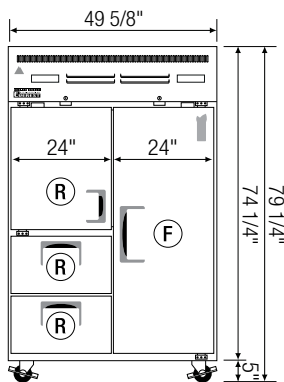
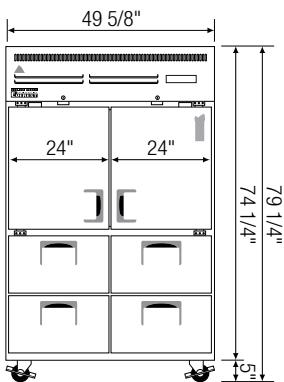
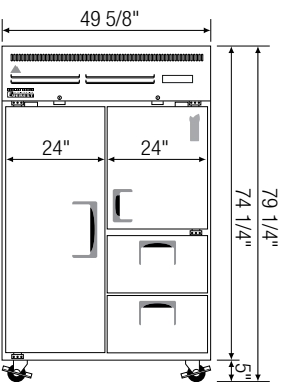
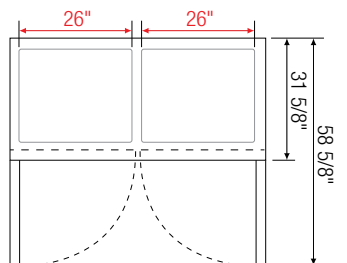
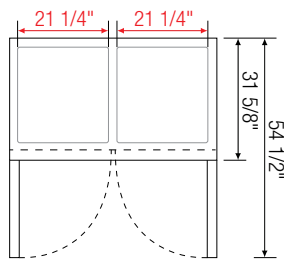
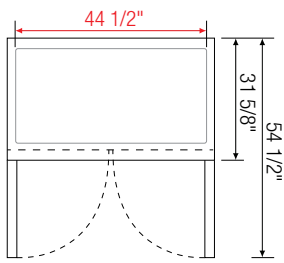
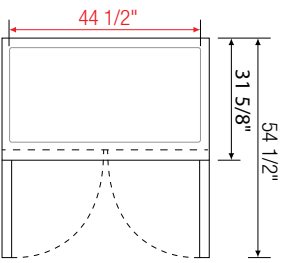
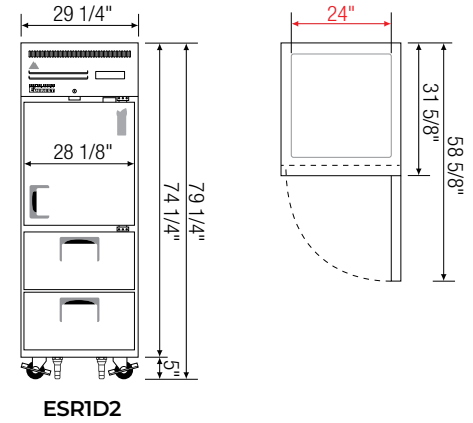
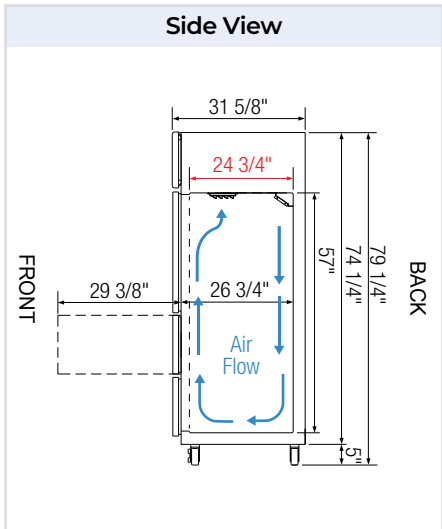

ESR2D2

ESR2D4

ESRF2D2
(Dual Temp)

ESWQ2D2
(Dual Temp)

Model	Ref/ Frz/ Dual	# of Doors	Capacity [†] (Cu. Ft.)	HP	BTU/HR [†]	Refrigerant	# of Shelves	Power (V-Hz-Ph)	Amps	Crated Weight (LBS)	Exterior Dimensions (Inches)		
											L	D	H*
ESR1D2	Ref	1 (H) 2 (DR)	23	1/4+	1,926	R290	2	115-60-1	3.3	340	29 1/4	31 5/8	74 1/4
ESR2D2	Ref	1 (FD) / 1 (H) 2 (DR)	48	1/3	2,311	R290	5	115-60-1	3	463	49 5/8	31 5/8	74 1/4
ESR2D4	Ref	2 (H) 4 (DR)	48	1/3	2,311	R290	4	115-60-1	3	479	49 5/8	31 5/8	74 1/4
ESRF2D2	Dual	1 (FD) / 1 (H) 2 (DR)	22 (R) 22 (F)	1/4+ (R) 1/2 (F)	1,926 (R) 1,670 (F)	R290 R290	5	115-60-1	9	525	49 5/8	31 5/8	74 1/4
ESWQ2D2	Dual	1 (FD) / 1 (H) 2 (DR)	39 (R) 13 (F)	1/4+ (R) 1/3 (F)	1,926 (R) 2,311 (F)	R290 R290	4	115-60-1	5.5	556	59	31 5/8	74 1/4

* Height does not include 5" for casters.

† Based on evaporating temperature of 23°F (-5°C) & condensing temperature of 131°F (55°C).

Ref = Refrigerator | Dual = Ref & Frz Combo
(FD) = Full Door | (H) = Half Door | (DR) = Drawer

Specifications subject to change without notice.

Product dimensions are for general purposes and not absolute value. Product capacity (†) is calculated based on standard industry figures. Slight variations may exist. If dimensions and capacity are critical, please contact Everest Refrigeration.