

# Upright Reach-In Freezers

TOP MOUNTED CONDENSING UNIT

ES SERIES



ESF1

ESFH2



ESF2

ESWF2



ESF3

## Cabinet Construction

- Heavy duty stainless steel interior/exterior with rounded corners for a hazard-free workspace.
- Open spaced interior with no walls between compartments.
- Galvanized steel top, bottom and rear.
- 2.5" thick high density polyurethane insulation.
- Four 5" swivel casters with locks on front set. Leg stabilizers standard for models ESF1, ESFH2 and ESF3.

## Refrigeration System

- Top mounted, self-contained and fully detachable Blizzard R290 condensing unit uses environmentally friendly, EPA-compliant R290 refrigerant with zero (0) Ozone Depletion Potential (ODP) and three (3) Global Warming Potential (GWP). Blizzard R290 is easily replaceable and requires no on-site brazing.
- Electronically commutated (ECM) fan motors achieve rapid cooling with less energy consumption.
- Full-length air duct and airflow guard ensure optimal cold air circulation.
- Air circulation guard keeps floor vents from obstruction.
- Time-initiated and temperature-terminated auto defrost heater.
- Large capacity, corrosion-resistant condenser and evaporator coils.
- Self-maintaining, energy-efficient condensate drain pan requires no external drains or electric heaters.
- High performance, auto-reverse condenser fan motor supports compressor ventilation and condenser coil cleaning.
- Pressure relief devices allow rapid cabinet re-entry.
- Pre-wired and ready to plug, 115V/60Hz/1Ph, (NEMA 5-15P for models ESF1, ESFH2, ESF2, and ESWF2), (NEMA 5-20P for model ESF3).

## Lighting

- Energy efficient silicone coated and shatter-proof LED lighting provides bright, high color illumination with low heat output.

## Doors

- Heavy duty stainless steel interior/exterior.
- 2.5" thick high density polyurethane insulation.
- Frame heaters prevent exterior moisture build up.
- Self-closing with adjustable torsion system for a positive seal.
- Snap-in magnetic gasket for ease of cleaning.
- High strength, recessed handles.
- Pre-installed locks keep your items safe from theft.
- Field reversible.

## Shelving

- Three epoxy coated, steel wire shelves per section.
- Height adjustable stainless steel clips.

## Temperature Control

- Multi-function digital controller with easy to read LED display.
- Factory preset temperature, -4°F. Temp-set range from -10°F to 54°F.
- Audible overheat protection alarm for compressor and condenser coil.

## Options

- Additional shelving.
- 3" swivel casters with locks.
- 3.5"-6" height-adjustable and interchangeable legs.
- Left hinged door.

← = Interior Dimensions      ↔ = Exterior Dimensions

**ABS Legs**



Two additional front adjustable stainless steel clad ABS legs for model ESF1 and ESFH2 provide extra stability when opening and closing doors, and one additional leg for ESF3 for weight support.

Equipped with 9 ft long NEMA 5-15P plug. (models ESF1, ESFH2, ESF2, ESWF2)

Equipped with 9 ft long NEMA 5-20P plug. (model ESF3)

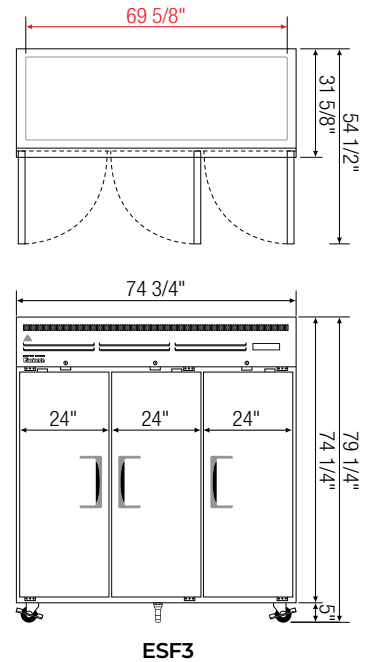
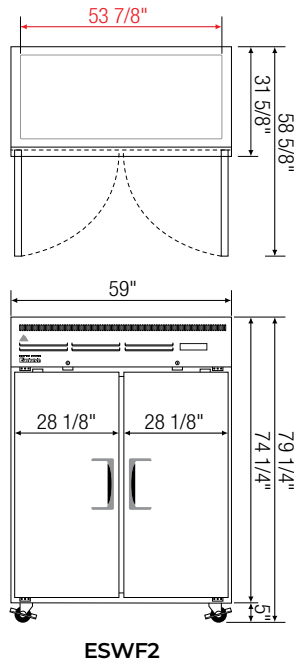
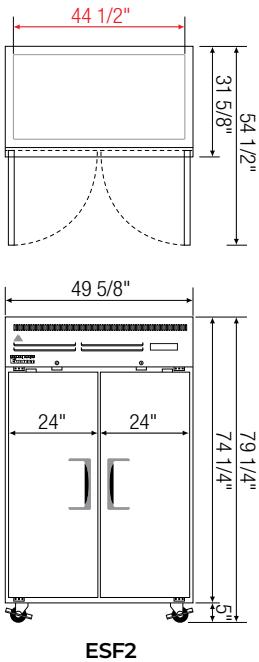
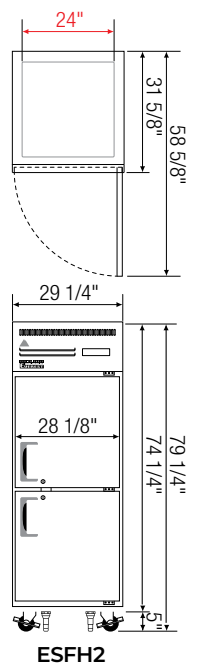
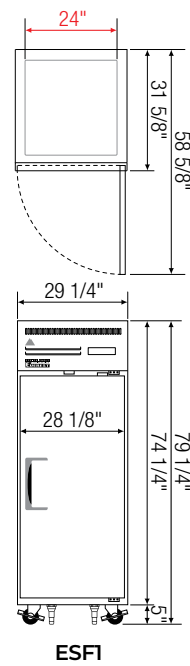
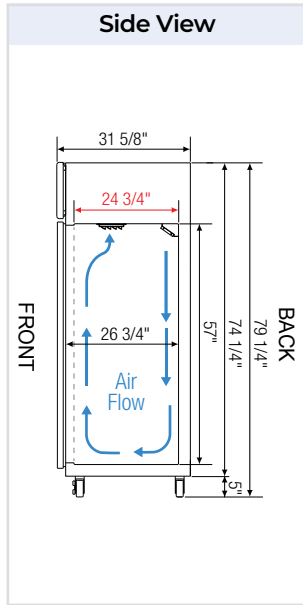

Model	Ref/ Frz/ Dual	# of Doors	Capacity <sup>†</sup> (Cu. Ft.)	HP	BTU/HR <sup>†</sup>	Refrigerant	# of Shelves	Power (V-Hz-Ph)	Amps	Crated Weight (LBS)	Exterior Dimensions (Inches)		
											L	D	H*
ESF1	Frz	1	23	1/2	1,670	R290	3	115-60-1	5	312	29 1/4	31 5/8	74 1/4
ESFH2	Frz	2 (H)	23	1/2	1,670	R290	3	115-60-1	5	322	29 1/4	31 5/8	74 1/4
ESF2	Frz	2	48	1	2,840	R290	6	115-60-1	7.5	450	49 5/8	31 5/8	74 1/4
ESWF2	Frz	2	55	1	2,840	R290	6	115-60-1	7.5	507	59	31 5/8	74 1/4
ESF3	Frz	3	71	3/4 x 2	2,690 x 2	R290	9	115-60-1	12	661	74 3/4	31 5/8	74 1/4

\* Height does not include 5" for casters.

Frz = Freezer | (H) = Half Door

† Based on evaporating temperature of 23°F (-5°C) & condensing temperature of 131°F (55°C).

Specifications subject to change without notice.

Product dimensions are for general purposes and not absolute value. Product capacity (†) is calculated based on standard industry figures. Slight variations may exist. If dimensions and capacity are critical, please contact Everest Refrigeration.