

Back Mount Sandwich Prep. Tables

BACK MOUNTED CONDENSING UNIT EPBN SERIES



EPBNR1



EPBNSR2



EPBNR2



EPBNWR2



EPBNR3

Cabinet Construction

- Heavy duty stainless steel interior/exterior with rounded corners for a hazard-free workspace.
- Open spaced interior with no walls between cabinet compartments.
- Vented stainless steel panel between top pan area and cabinet catches food debris.
- 16 gauge, high quality stainless steel worktop, lid and hood.
- Galvanized steel bottom and rear.
- 2.5" thick high density polyurethane insulation.
- Four 5" swivel casters with locks on front set.

Refrigeration System

- Back mounted, self-contained and fully detachable Blizzard R290 condensing unit uses environmentally friendly, EPA-compliant R290 refrigerant with zero (0) Ozone Depletion Potential (ODP) and three (3) Global Warming Potential (GWP). Blizzard R290 is easily replaceable and requires no on-site brazing.
- Front air breathing for flexibility in installation.
- Electronically commutated (ECM) fan motors achieve rapid cooling with less energy consumption.
- Full-length air duct ensures optimal cold air circulation.
- Time-initiated and temperature-terminated auto defrost cycle for seamless operation.
- Large capacity, corrosion-resistant condenser and evaporator coils.
- Self-maintaining, energy-efficient condensate drain pan requires no external drains or electric heaters.
- High performance, auto-reverse condenser fan motor supports compressor ventilation and condenser coil cleaning.
- Pressure relief devices allow rapid cabinet re-entry.
- Pre-wired and ready to plug, 115V/60Hz/1Ph, NEMA 5-15P.

Doors

- Heavy duty stainless steel interior/exterior.
- 2.5" thick high density polyurethane insulation.
- Frame heaters prevent exterior moisture build up.
- Self-closing with adjustable torsion system for a positive seal.
- Snap-in magnetic gasket for ease of cleaning.
- High strength, recessed handles.

Preparation Area

- NSF certified polycarbonate 6" deep pans (see table for quantity).
- 1/2" thick, foam insulated lid keeps top pan area cold and prevents moisture build-up.
- 12 1/4" deep cutting board is removable for ease of cleaning.

Shelving

- One epoxy coated, steel wire shelf per section.
- Height adjustable stainless steel clips.

Temperature Control

- Multi-function digital controller with easy to read LED display.
- Factory preset temperature, 35°F. Temp-set range from 33°F to 54°F.
- Audible overheat protection alarm for compressor and condenser coil.

Options

- NSF certified stainless steel double overshef.
- Additional shelving.
- 3" swivel casters with locks.
- 3.5"-6" height-adjustable and interchangeable legs.
- Left hinged door (applies to EPBNR1).

↔ = Interior Dimensions ↔ = Exterior Dimensions

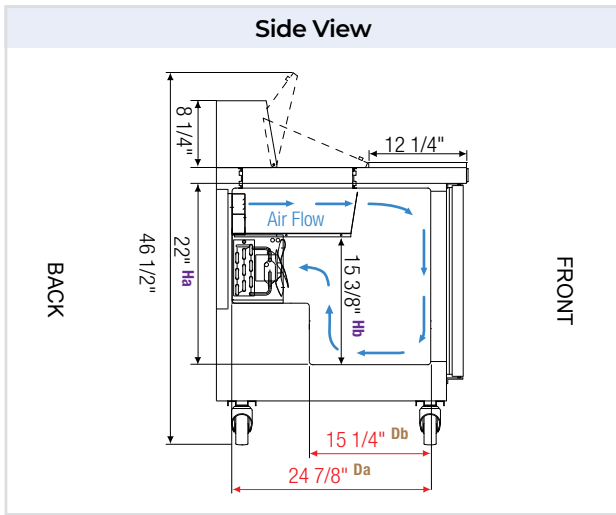

Equipped with 9 ft long NEMA 5-15P plug.

√ : Mounting space for overshef.

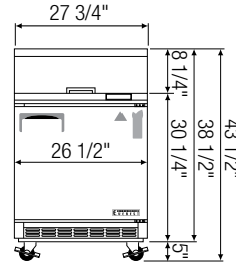
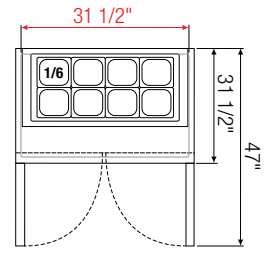
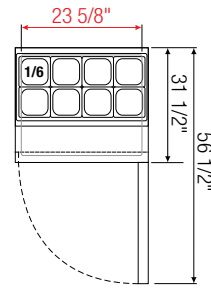

EPBNR1

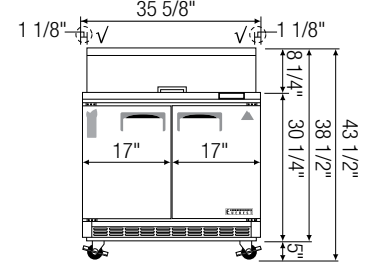

EPBNSR2

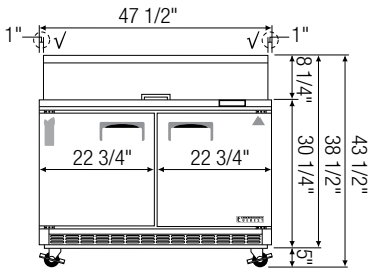
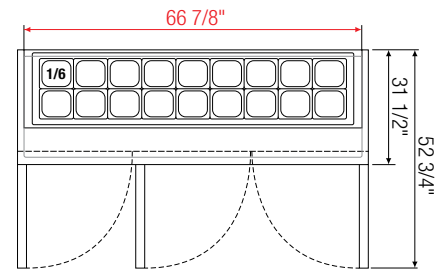
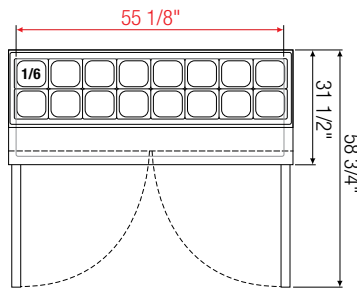
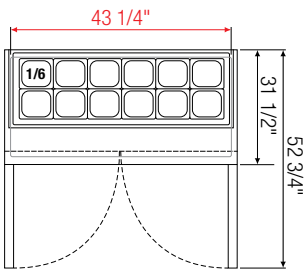

EPBNR2

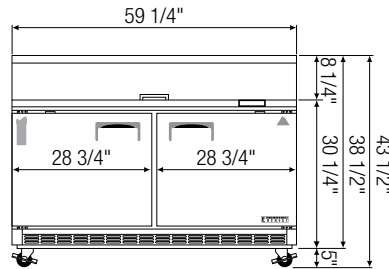

EPBNWR2

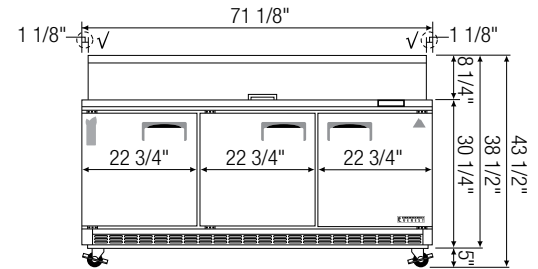

EPBNR3

Model	Ref/ Frz/ Dual	# of Doors	Capacity [†] (Cu. Ft.)	HP	Refrigerant	# of Shelves	# of Pans	Power (V-Hz-Ph)	Amps	Crated Weight (LBS)	Exterior Dimensions (Inches)		
											L	D ^a	H [*]
EPBNR1	Ref	1	8	1/5	R290	1	1/6 X 8	115-60-1	2.5	226	27 3/4	31 1/2	38 1/2
EPBNSR2	Ref	2	10	1/5	R290	2	1/6 X 8	115-60-1	2.5	268	35 5/8	31 1/2	38 1/2
EPBNR2	Ref	2	13	1/4+	R290	2	1/6 X 12	115-60-1	3.5	313	47 1/2	31 1/2	38 1/2
EPBNWR2	Ref	2	16	1/3	R290	2	1/6 X 16	115-60-1	2.5	382	59 1/8	31 1/2	38 1/2
EPBNR3	Ref	3	19	1/3	R290	3	1/6 X 18	115-60-1	3	426	71 1/8	31 1/2	38 1/2

* Height does not include 5" for casters.

^a Depth includes 12 1/4" cutting board.

Da, Db Interior Depth Ha, Hb Interior Height

Specifications subject to change without notice.

Product dimensions are for general purposes and not absolute value. Product capacity (†) is calculated based on standard industry figures. Slight variations may exist. If dimensions and capacity are critical, please contact Everest Refrigeration.

Ref = Refrigerator