



EBC37



EBC50



EBC65



EBC80



EBC95

Cabinet Construction

- Heavy duty stainless steel countertop and rails with textured laminate, black vinyl exterior.
- Open spaced interior with no walls between compartments.
- Galvanized steel interior.
- 1 3/4" thick high density polyurethane insulation.
- Built-in caster thread receptacles for all models.

Refrigeration System

- Side mounted, self-contained and fully detachable Blizzard R290 condensing unit uses environmentally friendly, EPA-compliant R290 refrigerant with zero (0) Ozone Depletion Potential (ODP) and three (3) Global Warming Potential (GWP). Blizzard R290 is easily replaceable and requires no on-site brazing.
- Electronically commutated (ECM) fan motors achieve rapid cooling with less energy consumption.
- Full-length air duct ensures optimal cold air circulation.
- Time-initiated and temperature-terminated auto defrost cycle for seamless operation.
- Large capacity, corrosion-resistant condenser and evaporator coils.
- Self-maintaining, energy-efficient condensate drain pan requires no external drains or electric heaters.
- High performance, auto-reverse condenser fan motor supports compressor ventilation and condenser coil cleaning.
- Pre-wired and ready to plug, 115V/60Hz/1Ph, NEMA 5-15P.

Lighting

- Shielded LED bar lighting with on/off switch provides bright, high color illumination at lower heat output.

Bottle Cap Opener

- Front mounted bottle cap opener and tray detach for ease of cleaning.

Lids

- Heavy duty stainless steel exterior and galvanized steel interior.
- 3/4" thick high density polyurethane insulation.
- Removable ratchet locks keep your items safe from theft.

Shelving

- Horizontal epoxy coated, steel wire shelves (see table for quantity).
- Vertical epoxy coated, steel wire bin dividers (see table for quantity).

Temperature Control

- Multi-function digital controller with easy to read LED display.
- Factory preset temperature, 35°F. Temp-set range from 33°F to 54°F.
- Audible overheat protection alarm for compressor and condenser coil.

Options

- Additional bin dividers.
- 3" or 5" swivel casters with locks.
- 3.5"-6" height-adjustable and interchangeable legs.

↔ = Interior Dimensions ← → = Exterior Dimensions

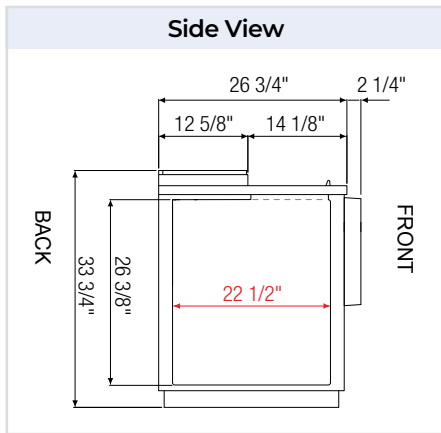

√ : Drain

T-Shaped PVC Drain Fittings w/ Movable Plug.

Separate hose attachment w/ 3/4" inner diameter required.

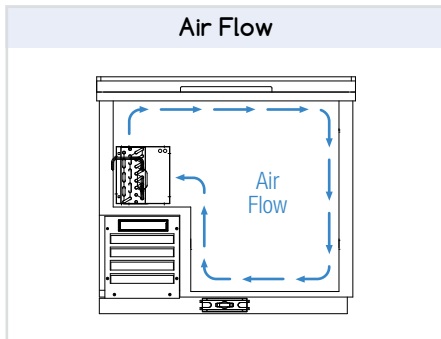
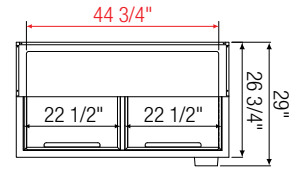
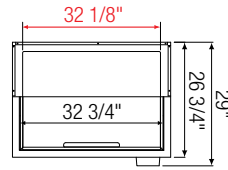
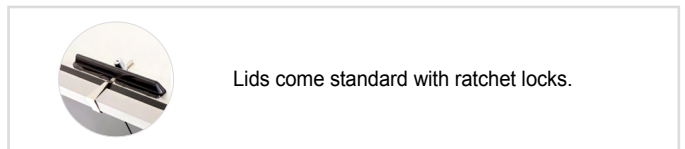

Equipped with 9 ft long NEMA 5-15P plug.

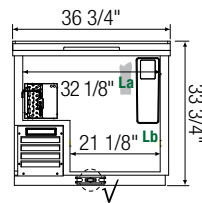

EBC37

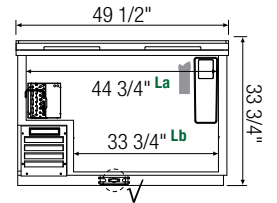

EBC50

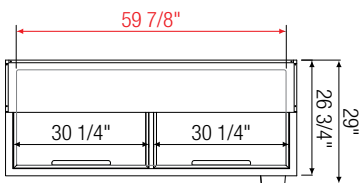

EBC65

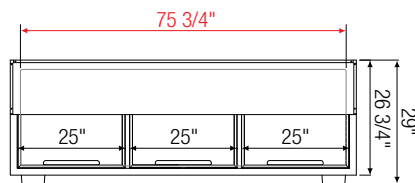

EBC80

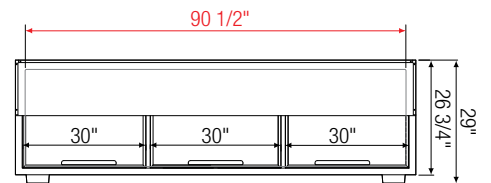

EBC95

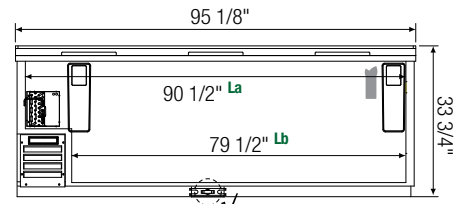
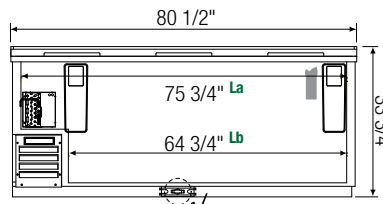
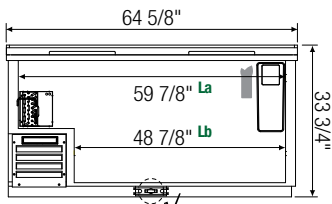

Model	Ref/ Frz/ Dual	# of Lids	Capacity (Cu. Ft.)	Capacity		# of Shelves	# of Bin Dividers	HP	Refrigerant	Power (V-Hz-Ph)	Amps	Crated Weight (LBS)	Exterior Dimensions (Inches)		
				12 oz. Cans	12 oz. Bottles								L	* D	H
EBC37	Ref	1	11	348	264	1	2	1/4+	R290	115-60-1	3.5	197	36 3/4	26 3/4	33 3/4
EBC50	Ref	2	15	576	396	2	3	1/4+	R290	115-60-1	3.5	235	49 1/2	26 3/4	33 3/4
EBC65	Ref	2	21	780	528	2	4	1/4+	R290	115-60-1	3.5	285	64 5/8	26 3/4	33 3/4
EBC80	Ref	3	26	1,008	720	3	5	1/3	R290	115-60-1	2.5	420	80 1/2	26 3/4	33 3/4
EBC95	Ref	3	31	1,320	900	3	6	1/3	R290	115-60-1	2.5	550	95 1/8	26 3/4	33 3/4

* Depth does not include bottle cap opener and tray.

Ref = Refrigerator

La, Lb Interior Length

Specifications subject to change without notice.

Product dimensions are for general purposes and not absolute value. Product capacity (P) is calculated based on standard industry figures. Slight variations may exist. If dimensions and capacity are critical, please contact Everest Refrigeration.