

# 24" DEEP GLASS DOOR BACK BAR COOLERS

EBB - Series • EBB48G-24 • EBB59G-24 • EBB69G-24 • EBB90G-24



▲ EBB48G-24



▲ EBB59G-24



▲ EBB69G-24



▲ EBB90G-24

## Cabinet Construction

- Heavy duty stainless steel countertop with textured laminate, black vinyl exterior.
- Galvanized steel interior walls and high quality stainless steel floor.
- 1 3/4" thick high density polyurethane insulation.
- Built-in caster thread receptacles for all models.

## Refrigeration System

- Side mounted, self-contained and fully detachable Blizzard R290 condensing unit uses environmentally friendly, EPA-compliant R290 refrigerant with zero (0) Ozone Depletion Potential (ODP) and three (3) Global Warming Potential (GWP). Blizzard R290 is easily replaceable and requires no on-site brazing.
- Electronically commutated (ECM) fan motors achieve rapid cooling with less energy consumption.
- Full-length air duct system ensures optimal circulation of cold air.
- Time-initiated and temperature-terminated auto defrost cycle for seamless operation.
- Large capacity, corrosion-resistant condenser and evaporator coils.
- Self-maintaining, energy-efficient condensate drain pan requires no external drains or electric heaters.
- High performance, auto-reverse condenser fan motor supports compressor ventilation and condenser coil cleaning. Refer to owner's manual for full maintenance instructions.
- Pre-wired and ready to plug, 115V/60Hz/1Ph, NEMA 5-15P.

## Lighting

- Shielded LED bar lighting with on/off switch provides bright, high color illumination at lower heat output.

## Doors

- Low emissivity double glass panes reflect UV rays for efficient cooling.
- Black PVC door frames.
- Snap-in magnetic door gasket make cleaning and replacement an easy process.
- High strength, die-cast door handles.
- Pre-installed door locks keep your items safe from theft.

## Shelving

- Two epoxy coated, steel wire shelves per section.
- Height adjustable stainless steel clips.

## Temperature Control

- Multi-function digital controller with easy to read LED display.
- Factory preset temperature, 35°F.
- Temperature setting range from 33°F to 54°F.
- Audible overheat protection alarm for compressor and condenser coil.

## Options

- Additional shelving.
- 3" or 5" swivel casters with locks.
- 3.5" – 6" height-adjustable and interchangeable legs.



## Dimensions

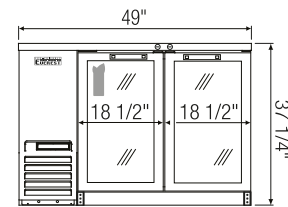
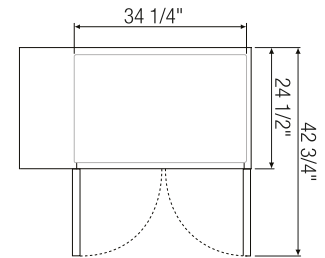
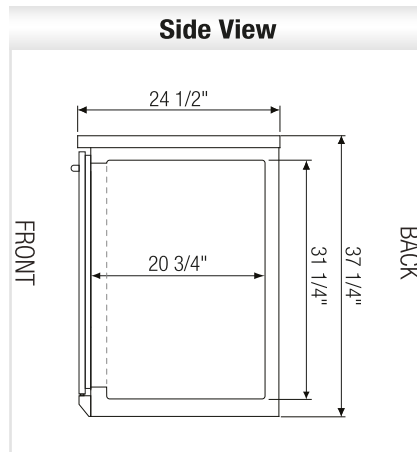
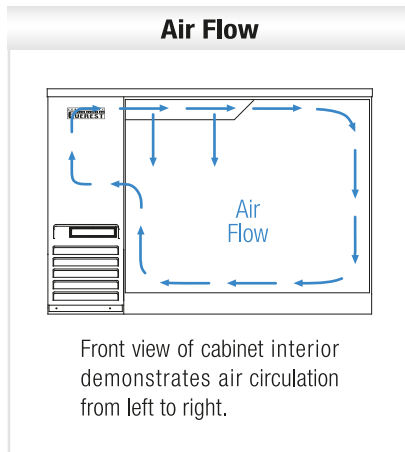

Equipped with 9 ft long NEMA 5-15P plug.

▲ **EBB48G-24**

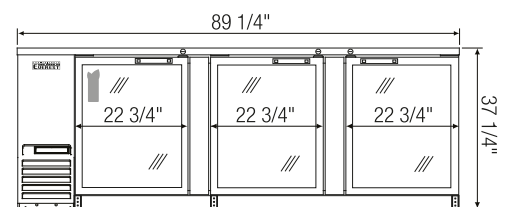
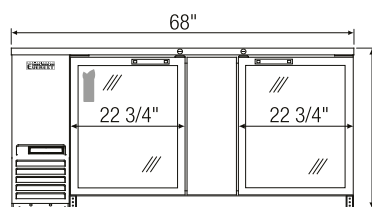
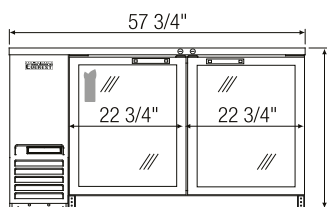
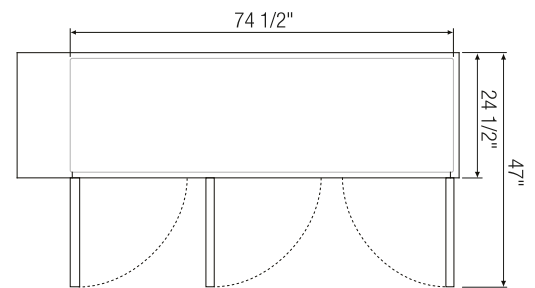
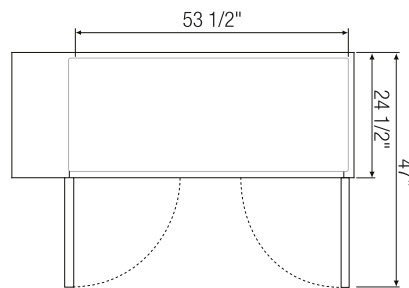
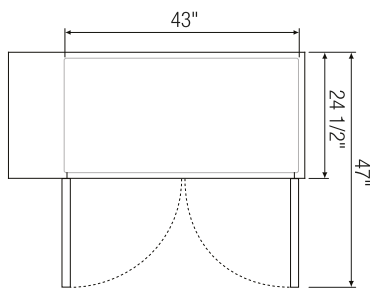

▲ **EBB59G-24**

▲ **EBB69G-24**

▲ **EBB90G-24**

Model	Ref/ Frz/ Dual	# of Doors	# of Shelves	Capacity (Cu. Ft.)	HP	BTU/HR †	Refrigerant	Capacity		Power (V-Hz-Ph)	Amps	Crated Weight (LBS)	Exterior Dimensions (Inches)		
								12 oz. Cans	12 oz. Bottles				L	D*	H
<b>EBB48G-24</b>	Ref	2	4	13	1/4+	1,926	R-290	420	294	115-60-1	3.5	277	49	24 1/2	37 1/4
<b>EBB59G-24</b>	Ref	2	4	17	1/4+	1,926	R-290	560	357	115-60-1	3.5	297	57 3/4	24 1/2	37 1/4
<b>EBB69G-24</b>	Ref	2	4	20	1/4+	1,926	R-290	700	441	115-60-1	3.5	328	68	24 1/2	37 1/4
<b>EBB90G-24</b>	Ref	3	6	28	1/3	2,311	R-290	980	609	115-60-1	2.5	446	89 1/4	24 1/2	37 1/4

\*: Depth does not include protruding door handles.

†: Based on evaporating temperature of 23°F (-5°C) & condensing temperature of 131°F (55°C).

Ref = Refrigerator

Specifications subject to change without notice.

Product dimensions are for general purposes and not absolute value. Product capacity (▲) is calculated based on standard industry figures. Slight variations may exist. If dimensions and capacity are critical, please contact Everest Refrigeration.



Please visit our website for updated Energy Efficiency information.