

OPEN AIR MERCHANDISERS

Vertical / 28" Deep / Tall

EOMV - Series

- EOMV-36-W-28-T • EOMV-36-B-28-T • EOMV-48-W-28-T • EOMV-48-B-28-T
- EOMV-60-W-28-T • EOMV-60-B-28-T • EOMV-72-W-28-T • EOMV-72-B-28-T

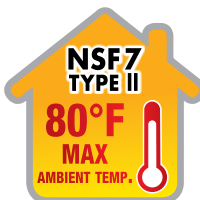

▲ EOMV-36-W-28-T



▲ EOMV-36-B-28-T



▲ EOMV-48-W-28-T



▲ EOMV-48-B-28-T



▲ EOMV-60-W-28-T



▲ EOMV-60-B-28-T



▲ EOMV-72-W-28-T



▲ EOMV-72-B-28-T

Cabinet Construction

- Black or white modern exterior has moisture-resistant panels and field-replaceable tempered glass.
- Heavy-duty stainless steel interior has perforated back wall for efficient air flow. Includes floor drains for ease of cleaning.
- Galvanized steel top, bottom and rear.
- 2.5" thick high-density polyurethane insulation.
- Integrated retractable night curtain saves energy and provides security.
- 5" swivel casters with locks on front set. Leg stabilizers standard for all models.

Refrigeration System

- Bottom mounted, self-contained and fully detachable Blizzard R290 condensing unit uses environmentally friendly, EPA-compliant R290 refrigerant with zero (0) Ozone Depletion Potential (ODP) and three (3) Global Warming Potential (GWP). Blizzard R290 is easily replaceable and requires no on-site brazing.
- Front air intake and rear air discharge design allows side by side installation.
- Conforms to **NSF Standard 7 TYPE II (maximum ambient temperature 80°F)**.
- Electronically commutated (ECM) evaporator fan motors achieve rapid cooling with less energy consumption.
- High performance, auto-reverse condenser fan motor supports compressor ventilation and condenser coil cleaning. Refer to owner's manual for full maintenance instructions.
- Large capacity, corrosion-resistant condenser and evaporator coils.
- Self-maintaining, energy-efficient condensate drain pan requires no external drains or electric heaters.
- Pre-wired and ready to plug, 115V/60Hz/1Ph, NEMA 5-15P and 230V/60Hz/1Ph, NEMA 6-20P (see table for plug types).

Lighting

- Shielded LED bar lighting under shelves and canopy provide bright, high color illumination at lower heat output. On/off switch saves energy.

Shelving

- Adjustable by height and angle. Position it flat or slanted downward at 10°.
- Heavy duty stainless steel shelves include price tag moldings.

Temperature Control

- Factory preset temperature of 35°F maintains a combined average product temperature of 40°F or less.
- Audible overheat protection alarm for compressor and condenser coil.

Recommended Operating Conditions

- **Conforms to NSF standard 7 TYPE II designed to operate in an air-conditioned environment where temperature and humidity do not exceed 80°F and 55% relative humidity.**
- Must not be installed near ventilation systems, fans or exterior doors or windows that will disrupt the air curtain and compromise the function of the cabinet.
- Must not be installed in direct sunlight.
- In built-in applications, a distance of 6" is required on the front, back and top exterior for ventilation purposes.



5 YEAR Compressor
2 YEAR Parts & Labor

Dimensions

↔ = Interior Dimensions ↔ = Exterior Dimensions

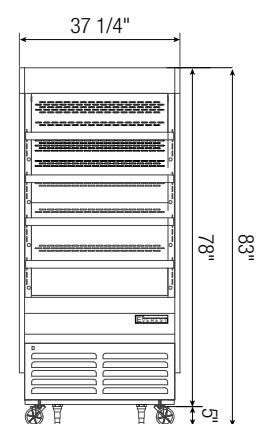
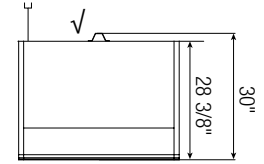
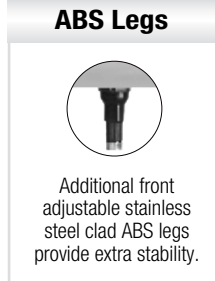
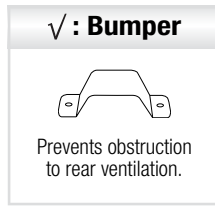
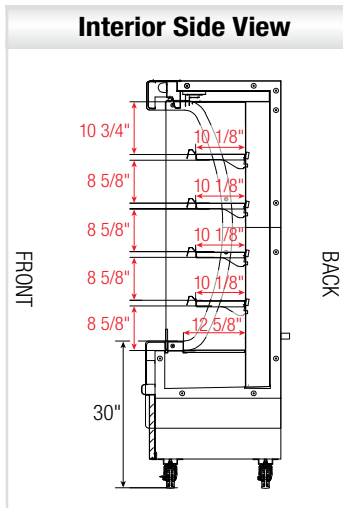
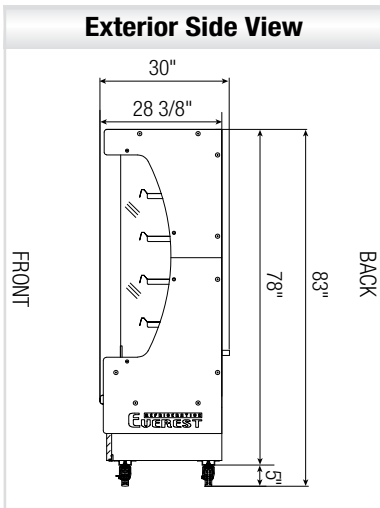

⏏ : Power Cord

5-20P 6-20P

Equipped with 9 ft long NEMA 5-20P or 6-20P plug. See table below.

▲ EOMV-36-W(B)-28-T

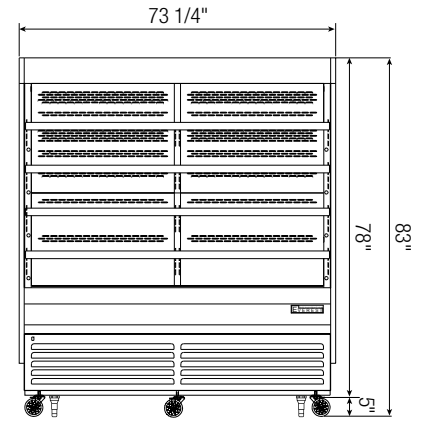
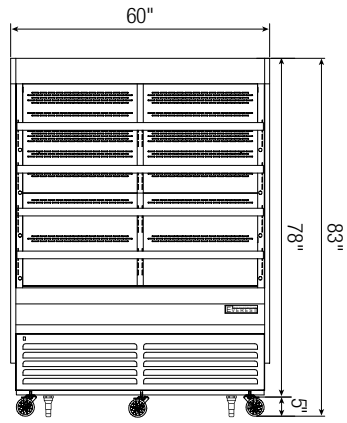
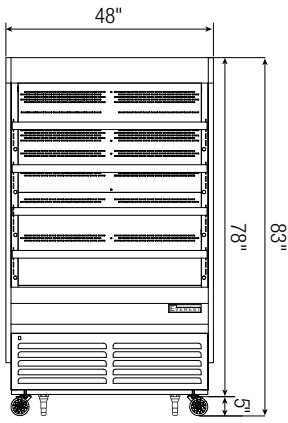
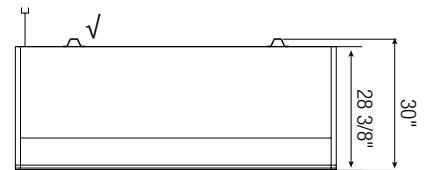
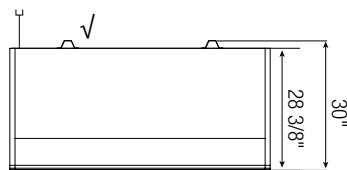
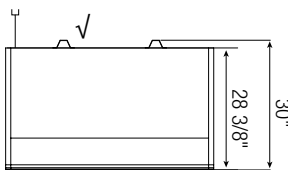

▲ EOMV-48-W(B)-28-T

▲ EOMV-60-W(B)-28-T

▲ EOMV-72-W(B)-28-T

Model	Ref/ Frz/ Dual	Capacity (Cu. Ft.)	HP	Refrigerant	# of Shelves	Power (V-Hz-Ph)	Amps	NEMA Config.	Exterior Dimensions (Inches)		
									L	D	H*
EOMV-36-W(B)-28-T	Ref	12.8	3/4	R290	4	115-60-1	8.53	5-20P	37 1/4	28 3/8	78
EOMV-48-W(B)-28-T	Ref	16.8	3/4 x 2	R290	4	115-60-1	14	5-20P	48	28 3/8	78
EOMV-60-W(B)-28-T	Ref	21.2	1x2	R290	8	230-60-1	10.84	6-20P	60	28 3/8	78
EOMV-72-W(B)-28-T	Ref	26	1x2	R290	8	230-60-1	11	6-20P	73 1/4	28 3/8	78

* : Height does not include 5" for casters.

Ref = Refrigerator

Specifications subject to change without notice.

Product dimensions are for general purposes and not absolute value. Product capacity (↑) is calculated based on standard industry figures. Slight variations may exist. If dimensions and capacity are critical, please contact Everest Refrigeration.



Please visit our website for updated Energy Efficiency information.